



Compact (*Purmo C*)

Radiatoarele panou PURMO COMPACT au panouri de încălzire profilate și elemente de convecție. Sunt prevăzute cu protecții laterale, protecție superioară tip grătar și patru racorduri cu filet interior G ½" care permit racordare la dreapta sau la stânga.

date tehnice

- Material: tablă de oțel de calitate superioară cu conținut scăzut de carbon laminată la rece DC01 conform EN 10130
- Grosimea nominală a tablei: panoul de încălzire - conform cu normele EN-442;
elementele de convecție - conform cu normele EN-442
- Distanța între canalele verticale cu apă: 33,3 mm
- Racorduri: 4 x G ½" laterale
- Presiunea de lucru: 10 bari
- Temperatura maximă: 110 °C
- Presiunea de probă: 13 bari
- Culoare: alb RAL 9016, alte culori din paleta RAL disponibile la comandă
- Accesorii: console de fixare, dop, ventil de aerisire în dotare.



vedere laterală

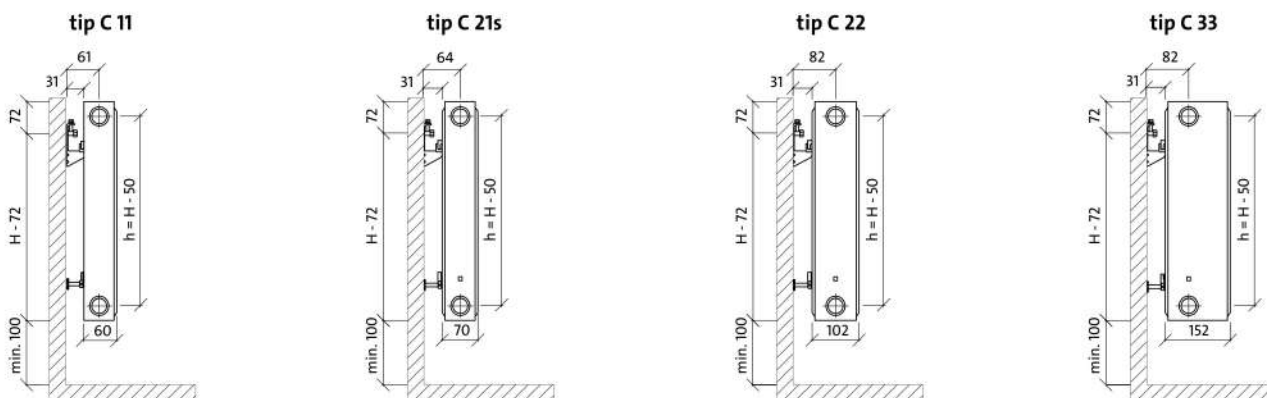

vedere din față

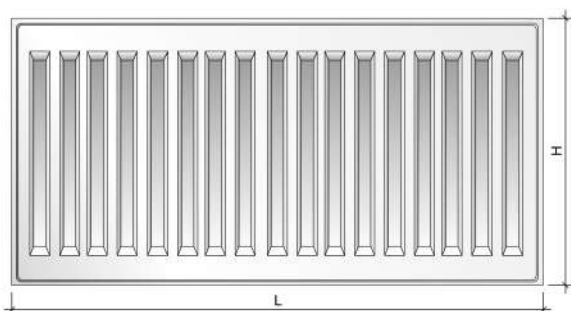

vedere din spate

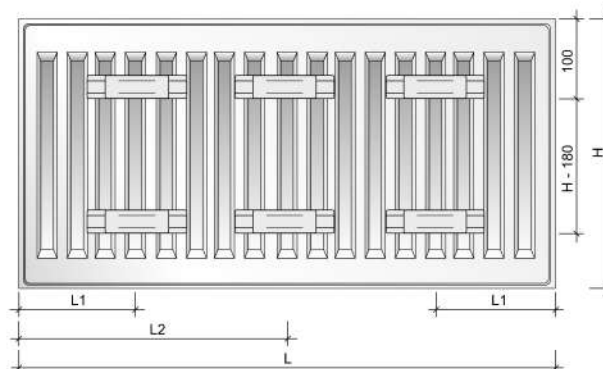

capacitate, masă și distanțe de montaj

capacitate: l/m

înălțime tip	300	450	500	550	600	900
11	1,7	2,5	2,7	3,0	3,2	4,5
21s	3,4	5,0	5,5	6,1	6,6	9,0
22	3,4	5,0	5,5	6,1	6,6	9,0
33	5,1	7,5	8,02	9,0	9,8	13,3

masă: kg/m

înălțime tip	300	450	500	550	600	900
11	9,1	13,9	15,5	17,1	18,7	28,3
21s	14,0	21,2	23,5	25,9	28,3	42,3
22	16,3	24,9	27,7	30,6	33,4	50,7
33	24,5	37,4	41,6	45,9	50,2	75,8

distanțe de montaj: mm

tip	C 11		C 21s, C 22, C 33		
	L	L1	L2	L1	L2
400-1600	117	-	133	-	-
1800	117	917	133	900	-
2000	117	1017	133	1000	-
2300	117	1150	133	1167	-
2600	117	1317	133	1300	-
3000	117	1517	133	1500	-

racordare recomandată

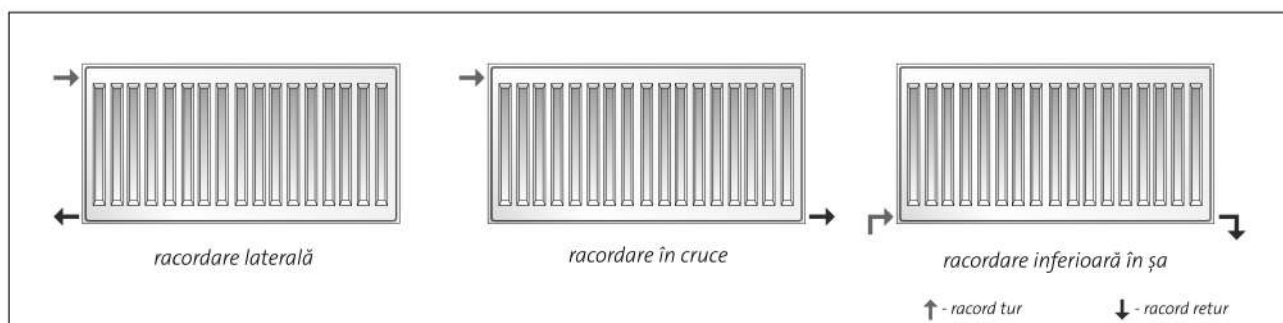



PURMO C 11



DESCRIERE: **PURMO C 11 600 x 1200**

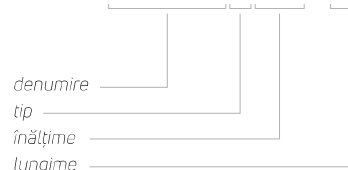

lungime [mm]	parametri $t_t / t_r / t_s$	înălțime [mm]					
		300	450	500	550	600	900
400	75/65/20 °C	218	316	347	378	407	571
	55/45/20 °C	112	161	177	192	207	289
500	75/65/20 °C	273	395	434	472	509	714
	55/45/20 °C	140	201	221	240	258	361
600	75/65/20 °C	328	474	521	566	611	856
	55/45/20 °C	167	241	265	288	310	433
700	75/65/20 °C	382	553	608	661	713	999
	55/45/20 °C	195	282	309	336	362	506
800	75/65/20 °C	437	632	694	755	814	1142
	55/45/20 °C	223	322	353	384	413	578
900	75/65/20 °C	491	711	781	850	916	1284
	55/45/20 °C	251	362	398	432	465	650
1000	75/65/20 °C	546	790	868	944	1018	1427
	55/45/20 °C	279	402	442	480	517	722
1100	75/65/20 °C	601	869	955	1038	1120	1570
	55/45/20 °C	307	443	486	528	569	795
1200	75/65/20 °C	655	948	1042	1133	1222	1712
	55/45/20 °C	335	483	530	576	620	867
1400	75/65/20 °C	764	1106	1215	1322	1425	1998
	55/45/20 °C	391	563	618	672	724	1011
1600	75/65/20 °C	874	1264	1389	1510	1629	2283
	55/45/20 °C	447	644	707	768	827	1156
1800	75/65/20 °C	983	1422	1562	1699	1832	2569
	55/45/20 °C	502	724	795	864	930	1300
2000	75/65/20 °C	1092	1580	1736	1888	2036	2854
	55/45/20 °C	558	805	883	960	1034	1445
2300	75/65/20 °C	1256	1817	1996	2171	2341	3282
	55/45/20 °C	642	926	1016	1104	1189	1662
2600	75/65/20 °C	1420	2054	2257	2454	2647	3710
	55/45/20 °C	726	1046	1148	1248	1344	1878
3000	75/65/20 °C	1638	2370	2604	2832	3054	4281
	55/45/20 °C	837	1207	1325	1439	1551	2167

Puterea termică a radiatoarelor (W) în conformitate cu EN 442 pentru parametrii 75/65/20°C și 55/45/20°C.

[W/m] 90/70/20°C coeficient n	686	994	1093	1189	1283	1800
	1,2981	1,3048	1,3070	1,3093	1,3115	1,3170

radiator la comandă

Compact *tip 21s*

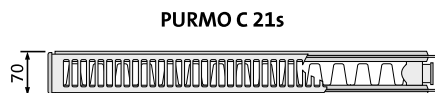
PURMO C 21s
DESCRIERE: PURMO C 21s 600 x 1200

denumire

tip

înălțime

lungime



lungime [mm]	parametri $t_t / t_r / t_s$	înălțime [mm]					
		300	450	500	550	600	900
400	75/65/20 °C	304	424	462	500	536	744
	55/45/20 °C	157	216	235	253	271	373
500	75/65/20 °C	381	530	578	625	670	931
	55/45/20 °C	196	271	294	317	338	466
600	75/65/20 °C	457	636	694	749	804	1117
	55/45/20 °C	236	325	353	380	406	559
700	75/65/20 °C	533	742	809	874	938	1303
	55/45/20 °C	275	379	412	443	474	652
800	75/65/20 °C	609	848	925	999	1072	1489
	55/45/20 °C	314	433	470	507	542	745
900	75/65/20 °C	685	954	1040	1124	1206	1675
	55/45/20 °C	353	487	529	570	609	838
1000	75/65/20 °C	761	1060	1156	1249	1340	1861
	55/45/20 °C	393	541	588	633	677	932
1100	75/65/20 °C	837	1166	1272	1374	1474	2047
	55/45/20 °C	432	595	647	696	745	1025
1200	75/65/20 °C	913	1272	1387	1499	1608	2233
	55/45/20 °C	471	649	706	760	812	1118
1400	75/65/20 °C	1065	1484	1618	1749	1876	2605
	55/45/20 °C	550	758	823	886	948	1304
1600	75/65/20 °C	1218	1696	1850	1998	2144	2978
	55/45/20 °C	628	866	941	1013	1083	1490
1800	75/65/20 °C	1370	1908	2081	2248	2412	3350
	55/45/20 °C	707	974	1059	1140	1218	1677
2000	75/65/20 °C	1522	2120	2312	2498	2680	3722
	55/45/20 °C	785	1082	1176	1266	1354	1863
2300	75/65/20 °C	1750	2438	2659	2873	3082	4280
	55/45/20 °C	903	1245	1353	1456	1557	2142
2600	75/65/20 °C	1979	2756	3006	3247	3484	4839
	55/45/20 °C	1021	1407	1529	1646	1760	2422
3000	75/65/20 °C	2283	3180	3468	3747	4020	5583
	55/45/20 °C	1178	1623	1764	1899	2031	2795

Puterea termică a radiatoarelor (W) în conformitate cu EN 442 pentru parametrii 75/65/20°C și 55/45/20°C.

[W/m] 90/70/20°C	954	1333	1456	1575	1691	2356
coeficient n	1,2803	1,3008	1,3076	1.3145	1,3213	1,3390

radiator la comandă



PURMO C 22



DESCRIERE: **PURMO C 22 600 x 1200**

denumire _____
tip _____
înălțime _____
lungime _____

lungime [mm]	parametri t ₁ / t _r / t ₂	înălțime [mm]					
		300	450	500	550	600	900
400	75/65/20 °C	384	539	588	636	684	955
	55/45/20 °C	195	272	296	320	343	474
500	75/65/20 °C	481	674	735	796	855	1194
	55/45/20 °C	244	340	370	400	428	592
600	75/65/20 °C	577	808	882	955	1025	1433
	55/45/20 °C	293	408	444	480	514	711
700	75/65/20 °C	673	943	1029	1114	1196	1672
	55/45/20 °C	342	476	518	560	600	829
800	75/65/20 °C	769	1078	1176	1273	1367	1910
	55/45/20 °C	391	544	592	640	685	948
900	75/65/20 °C	865	1212	1323	1432	1538	2149
	55/45/20 °C	440	612	666	720	771	1066
1000	75/65/20 °C	961	1347	1470	1591	1709	2388
	55/45/20 °C	488	680	740	799	857	1185
1100	75/65/20 °C	1057	1482	1617	1750	1880	2627
	55/45/20 °C	537	748	814	879	943	1303
1200	75/65/20 °C	1153	1616	1764	1909	2051	2866
	55/45/20 °C	586	816	888	959	1028	1422
1400	75/65/20 °C	1345	1886	2058	2227	2393	3343
	55/45/20 °C	684	952	1037	1119	1200	1659
1600	75/65/20 °C	1538	2155	2352	2546	2734	3821
	55/45/20 °C	781	1088	1185	1279	1371	1896
1800	75/65/20 °C	1730	2425	2646	2864	3076	4298
	55/45/20 °C	879	1224	1333	1439	1542	2133
2000	75/65/20 °C	1922	2694	2940	3182	3418	4776
	55/45/20 °C	977	1360	1481	1599	1714	2370
2300	75/65/20 °C	2210	3098	3381	3659	3931	5492
	55/45/20 °C	1123	1564	1703	1839	1971	2725
2600	75/65/20 °C	2499	3502	3822	4137	4443	6209
	55/45/20 °C	1270	1768	1925	2079	2228	3080
3000	75/65/20 °C	2883	4041	4410	4773	5127	7164
	55/45/20 °C	1465	2040	2221	2398	2571	3554

Puterea termică a radiatoarelor (W) în conformitate cu EN 442 pentru parametrii 75/65/20°C și 55/45/20°C.

[W/m] 90/70/20°C	1211	1701	1857	2012	2163	3033
coeficient n	1,3094	1,3226	1,3270	1,3314	1,3358	1,3561

radiator la comandă

Compact *tip 33*

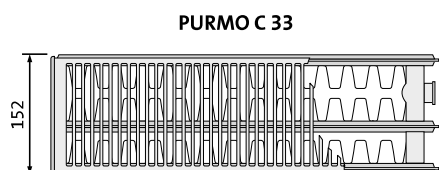
PURMO C 33
DESCRIERE: PURMO C 33 600 x 1200

denumire
tip
înălțime
lungime



lungime [mm]	parametri $t_1 / t_r / t_2$	înălțime [mm]					
		300	450	500	550	600	900
400	75/65/20 °C	539	748	814	879	942	1304
	55/45/20 °C	273	376	408	439	469	646
500	75/65/20 °C	674	935	1018	1099	1178	1630
	55/45/20 °C	341	470	510	549	587	807
600	75/65/20 °C	808	1121	1221	1318	1414	1956
	55/45/20 °C	410	564	612	659	704	968
700	75/65/20 °C	943	1308	1425	1538	1649	2282
	55/45/20 °C	478	657	714	768	821	1130
800	75/65/20 °C	1078	1495	1628	1758	1885	2608
	55/45/20 °C	546	751	816	878	939	1291
900	75/65/20 °C	1212	1682	1832	1977	2120	2934
	55/45/20 °C	615	845	918	988	1056	1453
1000	75/65/20 °C	1347	1869	2035	2197	2356	3260
	55/45/20 °C	683	939	1020	1098	1173	1614
1100	75/65/20 °C	1482	2056	2239	2417	2592	3586
	55/45/20 °C	751	1033	1122	1207	1291	1776
1200	75/65/20 °C	1616	2243	2442	2636	2827	3912
	55/45/20 °C	820	1127	1224	1317	1408	1937
1400	75/65/20 °C	1886	2617	2849	3076	3298	4564
	55/45/20 °C	956	1315	1427	1537	1643	2260
1600	75/65/20 °C	2155	2990	3256	3515	3770	5216
	55/45/20 °C	1093	1503	1631	1756	1877	2583
1800	75/65/20 °C	2425	3364	3663	3955	4241	5868
	55/45/20 °C	1229	1691	1835	1976	2112	2905
2000	75/65/20 °C	2694	3738	4070	4394	4712	6520
	55/45/20 °C	1366	1878	2039	2195	2347	3228
2300	75/65/20 °C	3098	4299	4681	5053	5419	7498
	55/45/20 °C	1571	2160	2345	2524	2699	3713
2600	75/65/20 °C	3502	4859	5291	5712	6126	8476
	55/45/20 °C	1776	2442	2651	2854	3051	4197
3000	75/65/20 °C	4041	5607	6105	6591	7068	9780
	55/45/20 °C	2049	2818	3059	3293	3520	4842

Puterea termică a radiatoarelor (W) în conformitate cu EN 442 pentru parametrii 75/65/20°C și 55/45/20°C.

[W/m] 90/70/20°C coeficient n	1698 1,3140	2363 1,3313	2576 1,3371	2784 1,3428	2988 1,3486	4143 1,3600
----------------------------------	----------------	----------------	----------------	----------------	----------------	----------------

radiator la comandă